

## Step6 : Glass Cement&Protecting Membrane

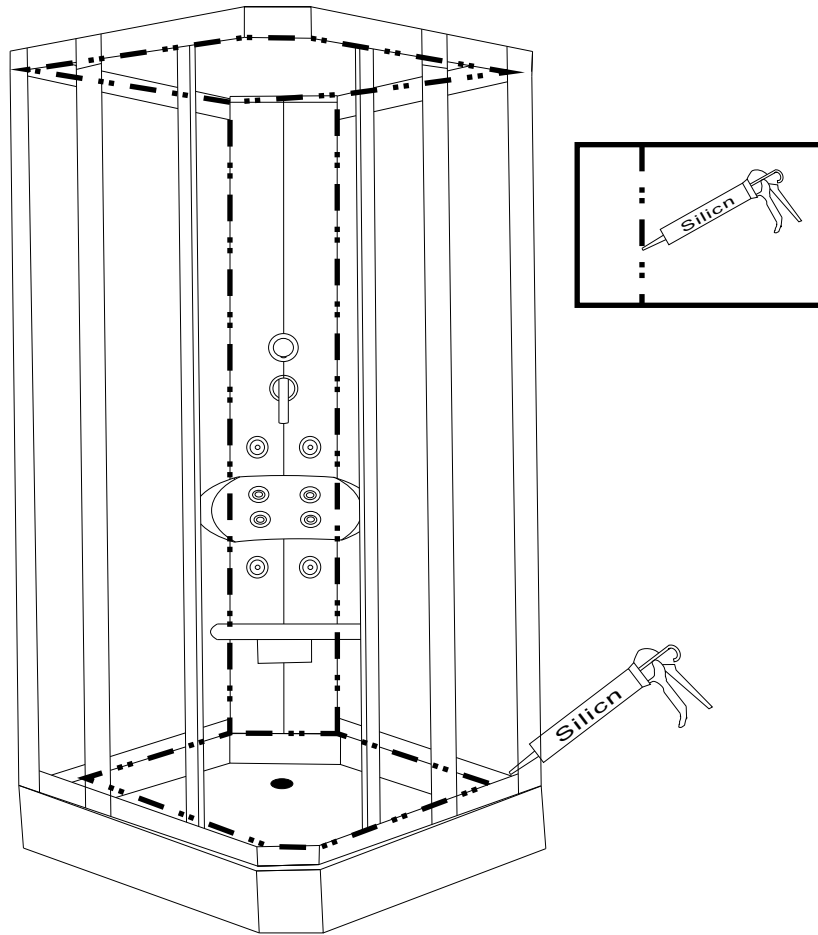

1. Check all the function. If ok, then use the silicon to make it waterproof. After 24 hours, you can use.

2. Remove the protective layer on the ABS tray and the roof. That will make it look nice.

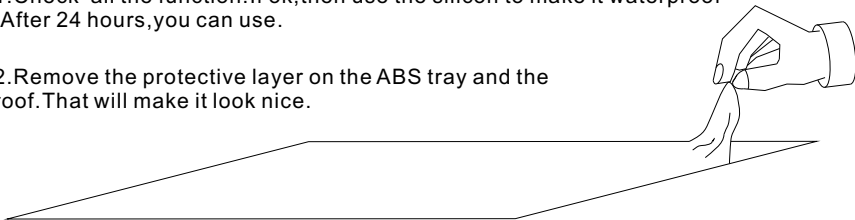

 **ENJOY YOUR SHOWER!**

# INSTALLATION MANUAL



(This picture only for reference)

SIZE: 90X90X215cm

## Part Of Accessories

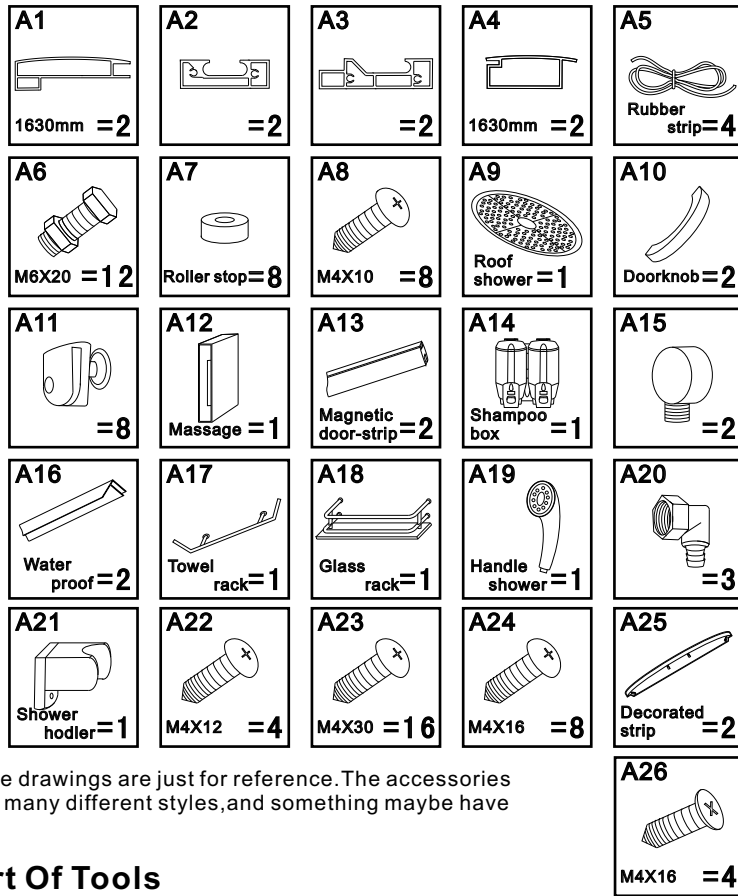

These drawings are just for reference. The accessories have many different styles, and something may have

## Part Of Tools

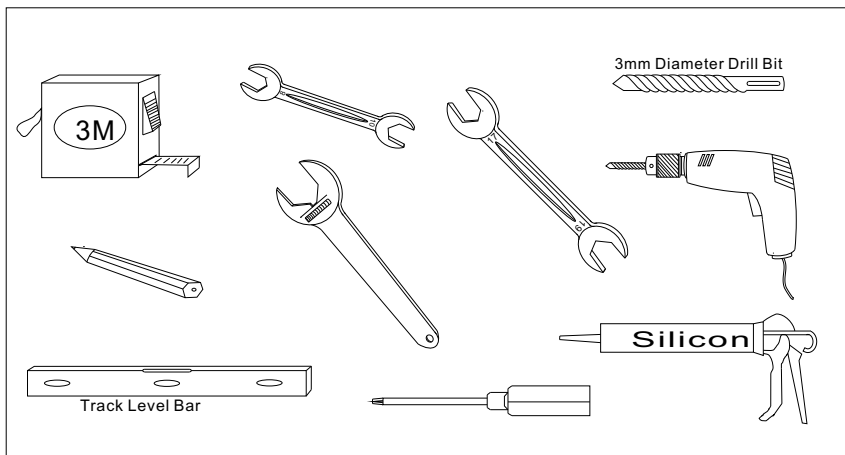

## Step5 : The Hose&Circuit

1. Match all the wire according to the same icon on the wire. Some styles do not have the control panel.
2. Connect the pipes to the roof-shower, the foot-massage, the handle shower. And if your style have a steam machine or other things, please connect the pipes and the wires as a correct way.
3. Install the hot and cold water pipe (you need to buy this two pipes yourself).

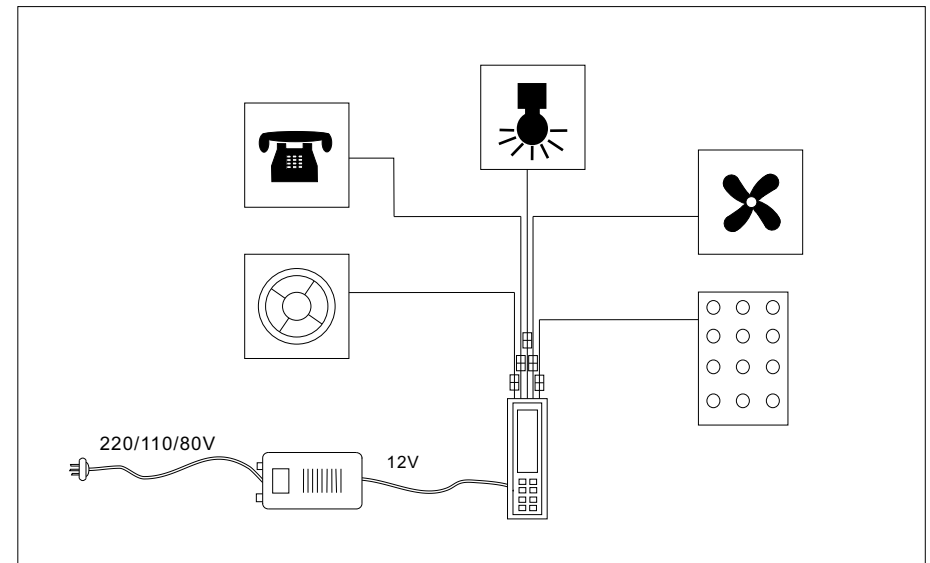
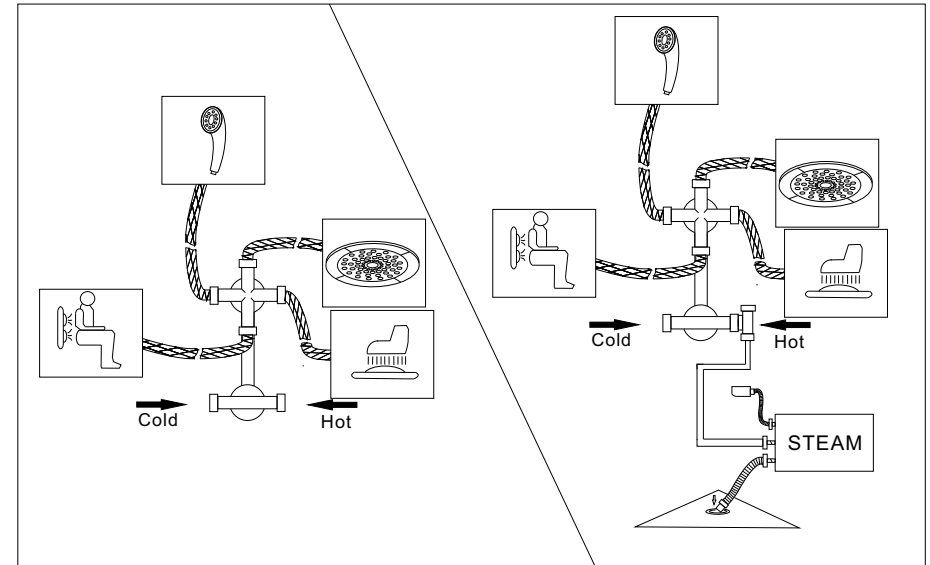

## Step2 : The Frontal Glass&Door

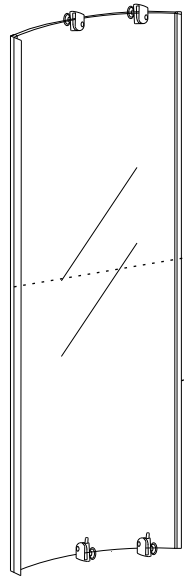

1. Fix the side aluminum to the two guideways, fasten the screws. Put the rubber strips on the side of the glasses. Fix the two side glasses on, and fix the two aluminum on.

2. Install the rollers on the doors. Fix the magnetic door-strip and the water-proof seal on the doors. Put the door rollers into the guideway, and adjust them.

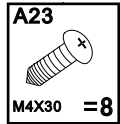
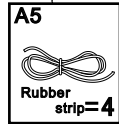
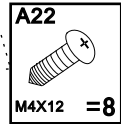
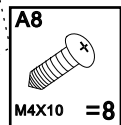
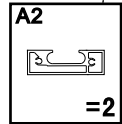
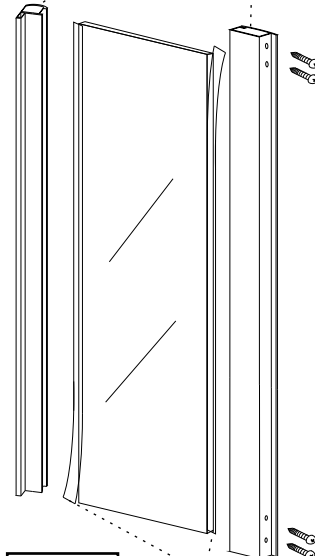
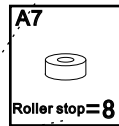
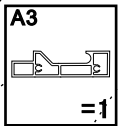
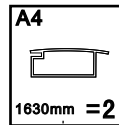
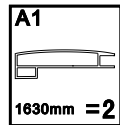
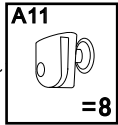
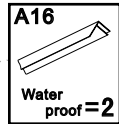

## Step3 : The Back&Ceiling

1. Put the whole front glass and two back glass onto the tray carefully, fix them on the basin, and the side aluminums (need drill holes), fasten the screws.

2. Put the two decorated-strip onto the panel. Install the central panel, drill holes, and then fasten the screws.

3. Put the roof on the top, and fasten the screws.

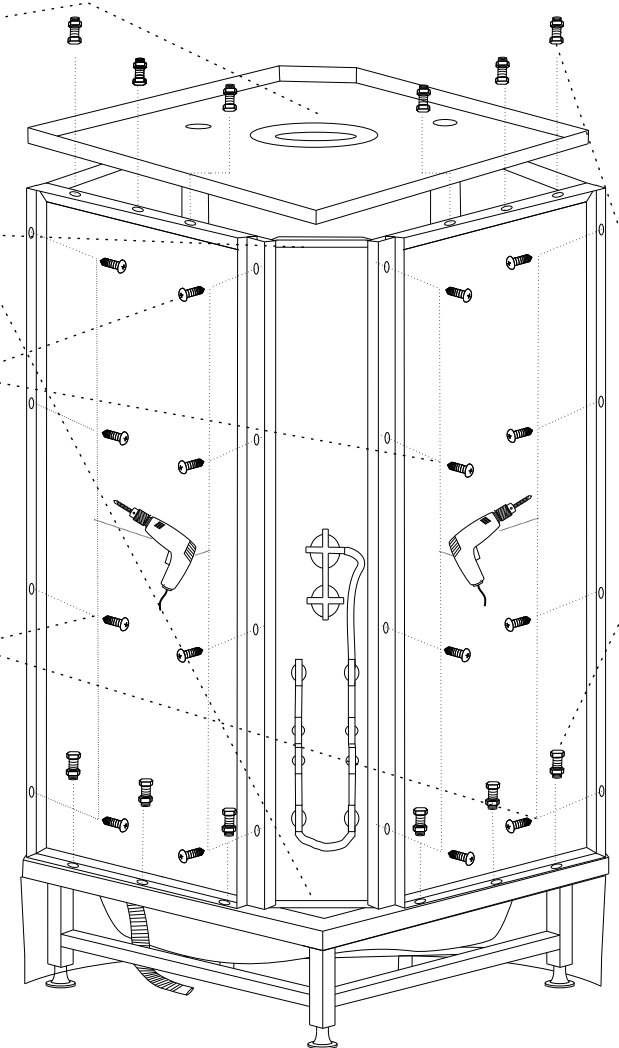
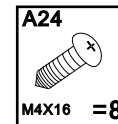
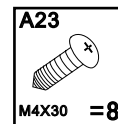
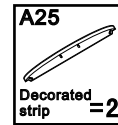
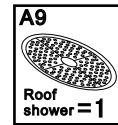

## Step4 : The Accessories On

1. Install all the accessories, like the handle shower, the shelf, the door-handle, the foot massage, and so on.

2. This picture is only for reference. The same model maybe have different styles, so the accessories may be a different quantity and different styles. Please according to the practical situation.

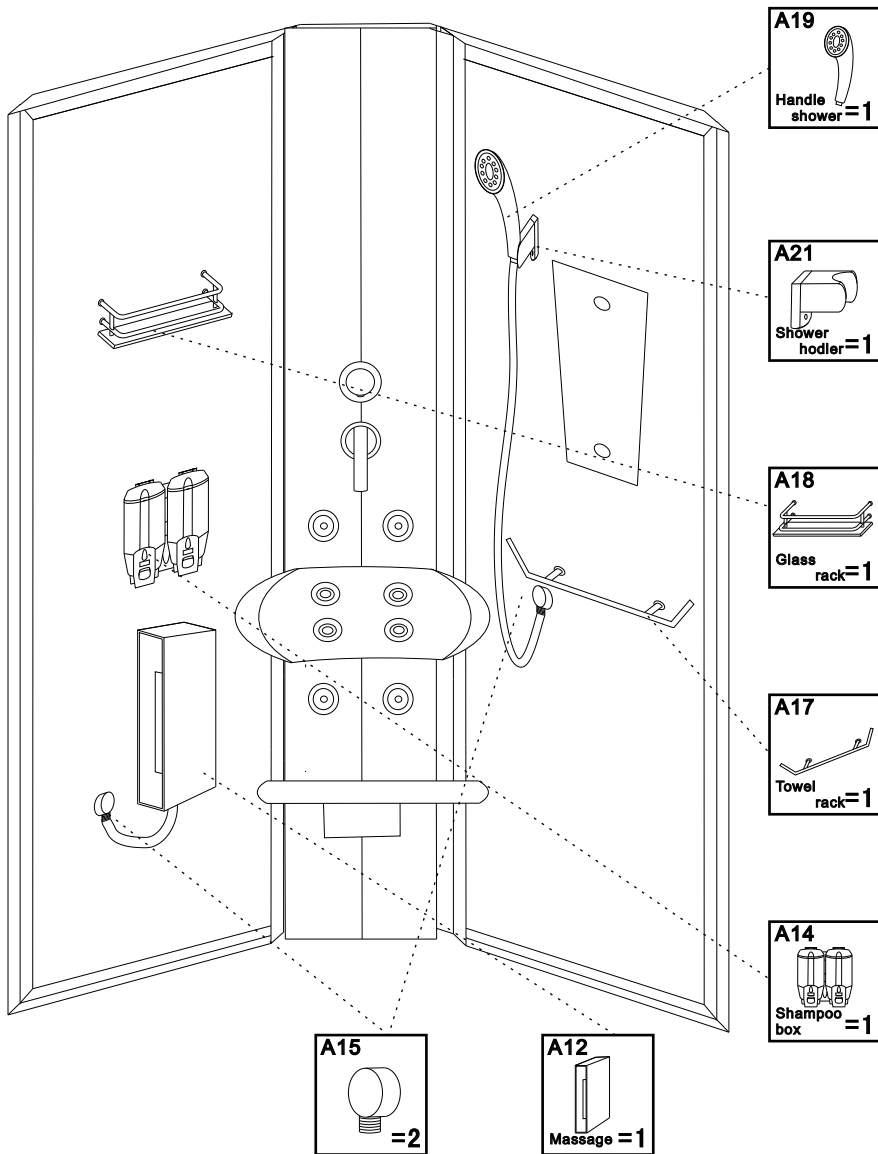

## Installation Manual

### Step1 : The Tray

1. This shower room is designed to position at a corner. The floor drain need to be a feasible position. The dimension in the picture is just for reference.

2. Connect drainpipe with drainer bend on the tray and insert the other end into drain hole on the ground.

3. Move bathtub at a suitable place and level tray with leveling pole. If it is not level, you just adjust screw to level it and fasten lock nuts.

