

## Installation for 15series SASCOM Bathroom Range

We recommend you use a professional plumber to install this product.

### Installation Instruction

1. Make sure all the necessary accessories to be existent, not any missing.
2. Level the ABS basin.
3. Fix the back and the computer panel with switch faucets using screws according to the respective place.
4. Combine the up and the bottom trails and the side pillar, insert the fixed black-color glass to the side pillar, then assemble and fix the alluminium pillar and the strip.
5. Install the pulleys to the mobile glasses, put them to the up and down alluminium trails, then fix the glass door handle.
6. Put the glass room on the ABS bottom basin, combine the backs and the side alluminium board, then mount the star background board in the middle of the two pieces of back glass.
7. Put the ABS Coping to the glass door, then fix them.
8. Adjust the mobile glass door, fix the magnetic strip and water proofbar.
9. Assemble various equipments of the back to the back, such as, towel shelf, shower, the massage, the glass shelf and the handle shower clip.
10. Adjust the mobile glass door.
11. Airproof the thoroughly shower room with glass cement.
12. Link well hot & cold switch water tap and electricity.
13. Move the shower room to the suitable basement.

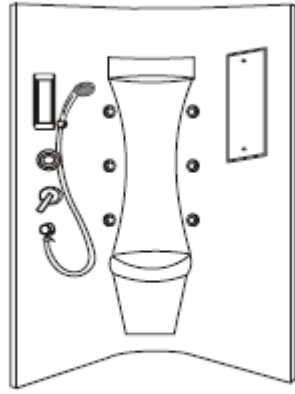

1



2

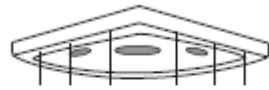



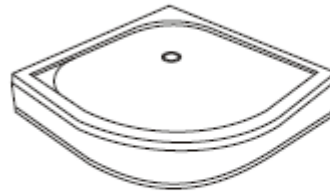





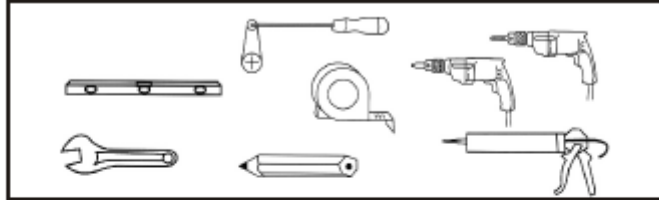

















3



4

2



- A**
- |  |   |  |  |
|--|---|--|--|
| A1<br><br>6x25 X4 | A3<br><br>X4 | A4<br><br>6x20 X4 | A5<br><br>M |
|--|---|--|--|
- B**
- |   |   |   |   |  |
|---|---|---|---|--|
| B1<br><br>M4x20 X2 | B2<br><br>X2 |   |   |  |
| B3<br><br>X2       | B4<br><br>X3 | B5<br><br>X2 | B6<br><br>X3 | B7<br><br>X1 |
- C**
- |  |   |  |  |
|--|---|--|--|
| C1<br><br>M4x10 X8 | C2<br><br>4x12 X4 | C3<br><br>X4 | C4<br><br>X2 |
|--|---|--|--|
- D**
- |   |   |   |   |
|---|---|---|---|
| D1<br><br>X8 | D2<br><br>X8 | D3<br><br>X8 | D4<br><br>X8 |
|---|---|---|---|
- E**
- |   |   |   |   |  |   |
|---|---|---|---|--|---|
| E1<br><br>M4x16 X8 | E2<br><br>X8 | E3<br><br>X2 | E4<br><br>X2 | E5<br><br>X2 | E6<br><br>X2 |
|---|---|---|---|--|---|

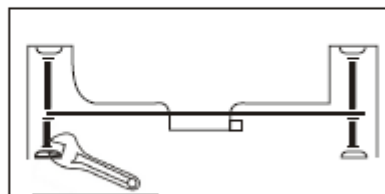
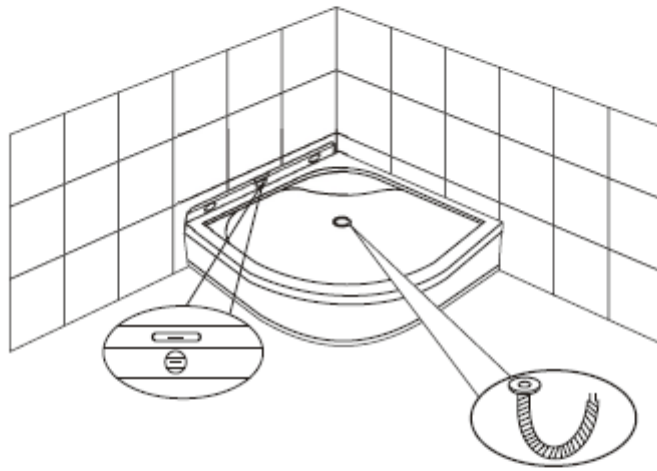
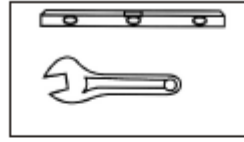

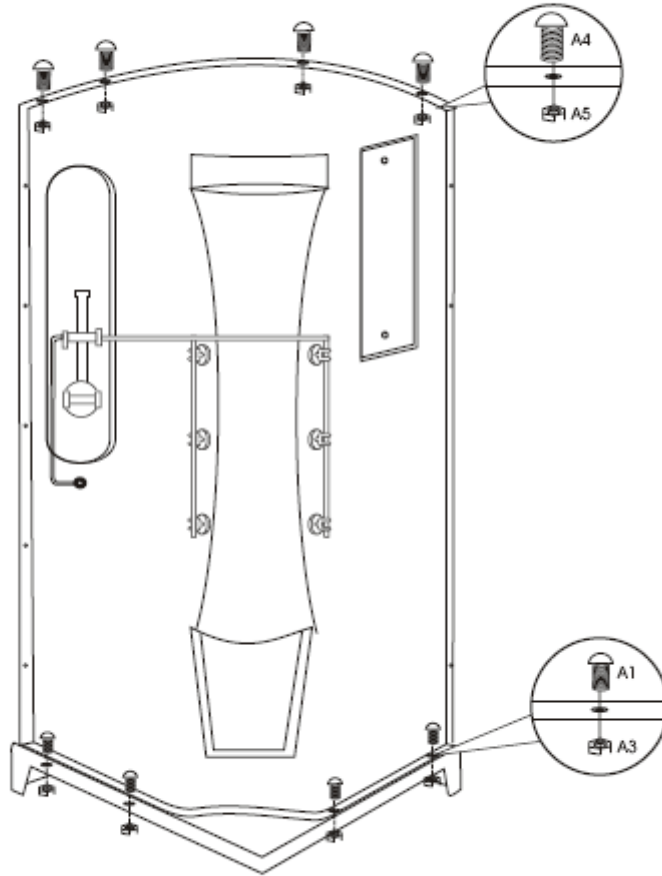
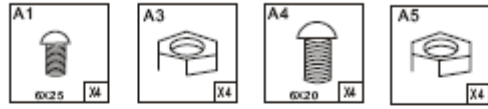

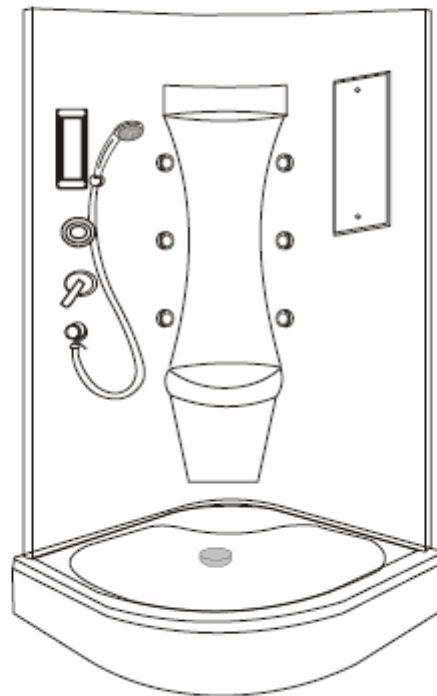
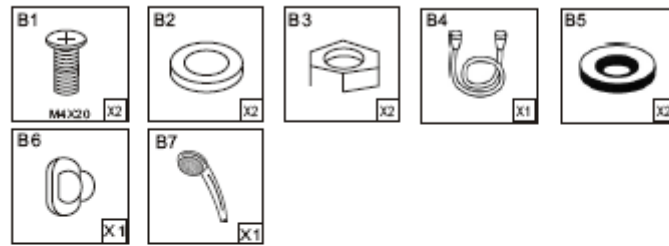

6

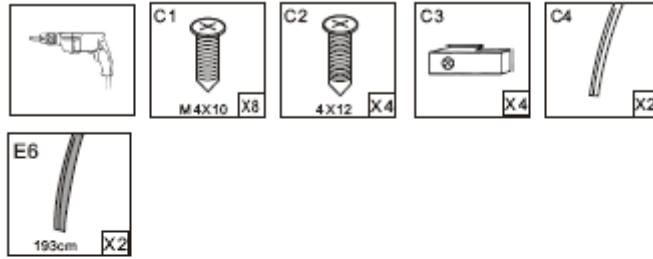

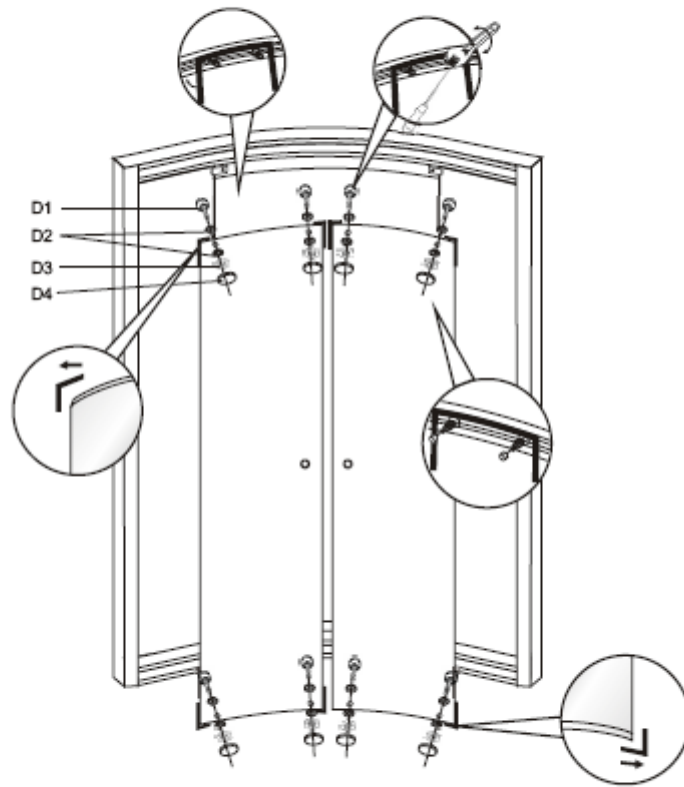
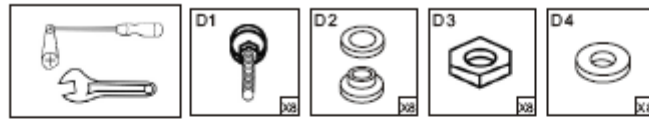

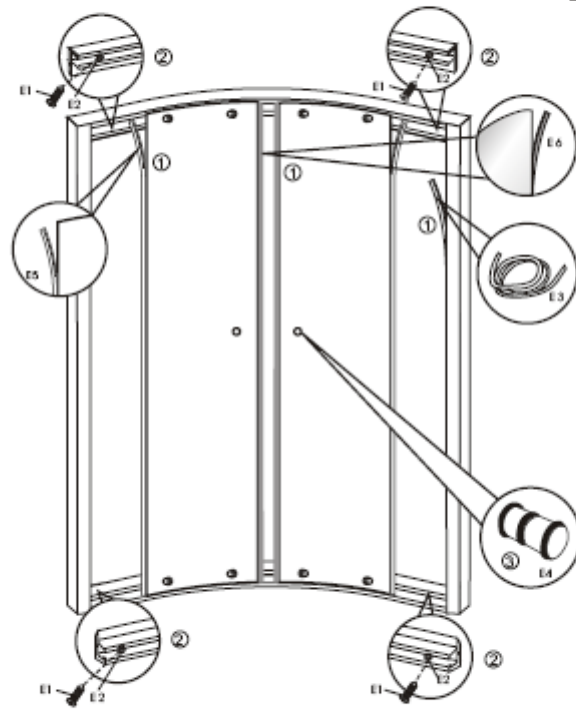
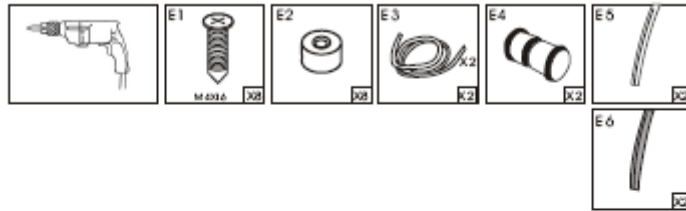

## NOTE

1. Unattached electronic parts that can produce steam or wet are not allowed to be used in shower room.

2. Warning: Children are forbidden to use this equipment alone without the instructing of the adult.

3. Earth-connecting apparatus must ever connect with the earth-touch line.

4. This equipment should be fixed an extral electric-current device (RCD) used to control the extral current no more 30ma.

5. In order to guarantee safety, the electronic lines, once broken, must be amended by the producer other mending apartments or similar professors in this field.

**SASCOM**  
**Products**

[www.sascomproducts.com](http://www.sascomproducts.com)